

DATENBLATT – BASE L50 - LINEAR
SIMPLIFIED WALLWASHER
VISUELLE WIRKUNG OHNE KOMPLEXE OPTIK

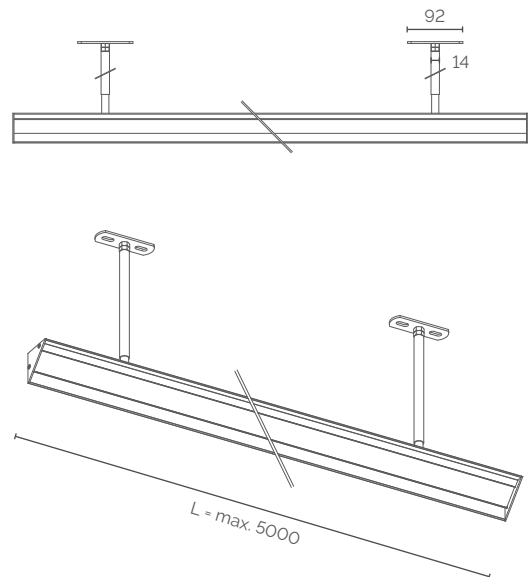
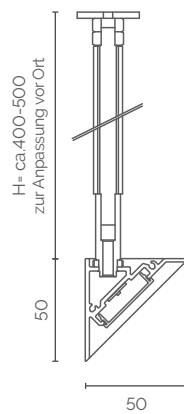
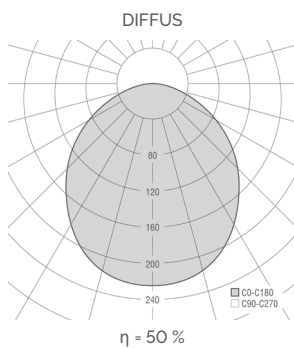

Montageart	Pendelleuchte
Oberfläche	Aluminium natur eloxiert, schwarz oder weiß pulverbeschichtet RAL oder NCS Farbtöne auf Anfrage
Cover	satiniert diffuse Lichtverteilung
LED Platine	Lichtfarben 2600K 2650K 2700K 3000K 4000K oder tuneable white 2600K - 6500K Lichtfarbe nach Wahl Bestückungsvarianten auf Anfrage

Leistung pro Laufmeter	14 W/m - 19,2 W/m 24V
Abmessungen	H: 50 mm B: 50 mm L: auf Kundenwunsch max. Profillänge 5000mm
Schutzart	IP44
Gewicht	ca. 900 g pro Meter

Entsprechender LED Driver ausgelagert | bitte separat bestellen





LED BAND - TECHNISCHE DATEN

MONO

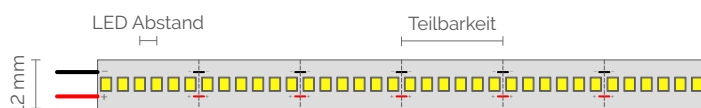

W / m	IP	CTT in K	φ LED lm / m	# LED / m	LED Abstand mm	Teilbarkeit mm	code
19,2	68	2600	1700	240	4,17	25	22Q-J447248-FS
19,2	68	3000	1750	240	4,17	25	22Q-J441248-FS
19,2	68	4000	1800	240	4,17	25	22Q-J445248-FS
14,4	68	2600	1250	180	4,17	25	22Q-J437188-FS
14,4	68	3000	1300	180	4,17	25	22Q-J431188-FS
14,4	68	4000	1350	180	4,17	25	22Q-J435188-FS

TUNEABLE WHITE

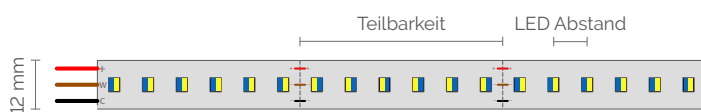

W / m	IP	CTT in K	φ LED lm / m	# LED / m	LED Abstand mm	Teilbarkeit mm	code
19,2	65	TW 2500/6000	600 700	120	8,33	50	22Q-4TW127

Flexibles LED Band, Rollenlänge 5m, Silikonverguß,
 rückseitig mit 3M Klebeband, Ausstrahlungswinkel: 120°,
 Umgebungstemperatur: -30°/+60° C,
 Lebensdauer: 30.000 h
 direkte Sonneneinstrahlung meiden

LED Konverter separat bestellen

LED Lichtstrom und Leistung je nach verfügbarer Selektion +/- 10%
 Toleranz Lichtfarbe +/- 150K

LED BAND - TECHNISCHE DATEN



RGBW

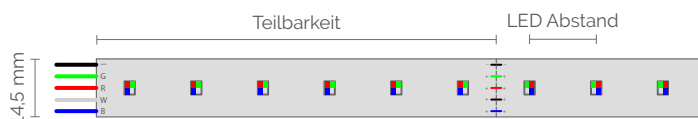

W / m	IP	CTT in K	φ LED lm / m	# LED / m	LED Abstand mm	Teilbarkeit mm	code
19.2	67	RGBW	R 120 G 300 B 110 W 840	60	16,67	100	21QRGB41WW-67

Flexibles LED Band, Rollenlänge 5m, Silikonverguß,
 rückseitig mit 3M Klebeband, Ausstrahlungswinkel: 120°,
 Umgebungstemperatur: -30°/+60° C,
 Lebensdauer: 30.000 h
 direkte Sonneneinstrahlung meiden

LED Konverter separat bestellen

LED Lichtstrom und Leistung je nach verfügbarer Selektion +/- 10%
 Toleranz Lichtfarbe +/- 150K

LED BAND DOTFREE - TECHNISCHE DATEN



MONO

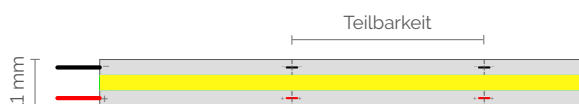

W / m	IP	CTT in K	φ LED lm / m	# LED / m	LED Abstand mm	Teilbarkeit mm	code
14	67	2650	1350	dotfree	-	45	22Q-14COB77
14	67	3000	1400	dotfree	-	45	22Q-14COB17
14	67	4000	1450	dotfree	-	45	22Q-14COB57

TUNEABLE WHITE



W / m	IP	CTT in K	φ LED lm / m	# LED / m	LED Abstand mm	Teilbarkeit mm	code
19	67	TW 2700/6500	850 900	dotfree	-	42	22Q-19COBTW7

Flexibles LED Band, Rollenlänge 5m, Silikonverguß,
 rückseitig mit 3M Klebeband, Ausstrahlungswinkel: 120°,
 Umgebungstemperatur: -30°/+60° C,
 Lebensdauer: 30.000 h
 direkte Sonneneinstrahlung meiden

LED Konverter separat bestellen

LED Lichtstrom und Leistung je nach verfügbarer Selektion +/- 10%
 Toleranz Lichtfarbe +/- 150K

