

Montageart	Aufbau-, Einbau- und Pendelleuchte
Oberfläche	Aluminium natur eloxiert, schwarz oder weiß pulverbeschichtet RAL oder NCS Farbtöne auf Anfrage
Fokus Linse	Lichtfarben 2700 K 3000 K 4000 K oder tuneable white 2700 5700 K Lichtfarbe nach Wahl Bestückungsvarianten auf Anfrage
Ausstrahlwinkel	2 × 22° 2 × 37°

Leistung pro Linse	monocolour 4 W tuneable white 2 W (DT8)
Abmessungen	H: 65 mm B: 48 mm Einbautiefe: min. 105 mm Deckenausschnitt: B- 52 mm x Länge - 6 mm L: auf Kundenwunsch max. Profillänge 6000 mm
Schutzart	IP20

Entsprechender LED Konverter hinter Blindteil der Leuchte oder als Deckeneinwurfgerät.



IP20



**DATENBLATT – BASE 65 - GRADO
BESPOKE
KONFIGURATIONSMÖGLICHKEITEN**



MONTAGEARTEN

Einbauleuchten

Aufbauleuchten

Pendelleuchten

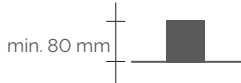

Breite 50 mm x Länge + 2 mm, randlos

LED PLATINE - AUSWAHL ZUR KONFIGURATION

MONO+TW 1480lm / 16W

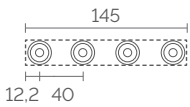

MONO+TW 1480lm / 16W

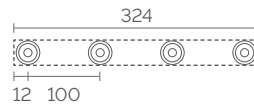

LÄNGE PROFIL

max # 8 optics / driver - monocolour
max # 16 optics / driver - tuneable white

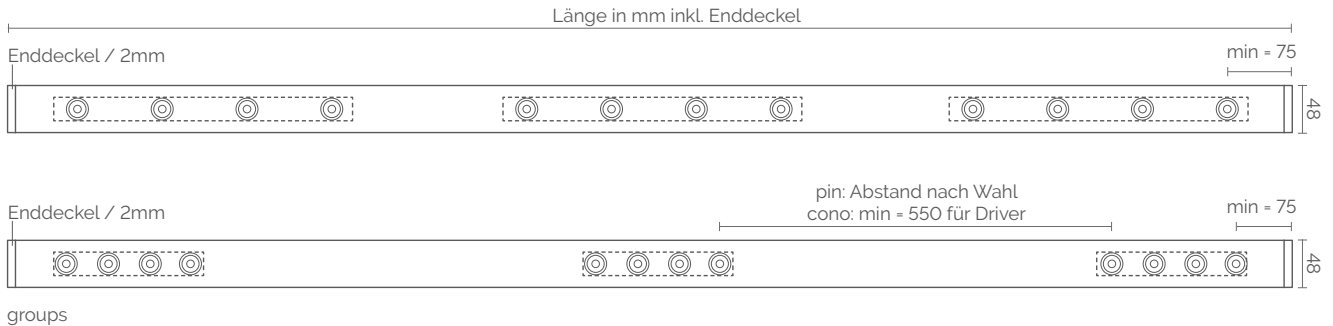

PROFIL OBERFLÄCHE

2x22° + Pin
2x37° + Pin
2x22° + Cono
2x37° + Cono

FARBEN CONO

schwarz
chrom
kupfer
gold

PROFIL OBERFLÄCHE

A6 / Co aluminium eloxiert
RAL 9016 FS verkehrsweiss
RAL 9005 FS tiefschwarz
weitere RAL oder NCS Farbtöne auf Anfrage

ENERGIEVERSORGUNG DRIVER

in Profil integriert:
non dimmable
DALI dimmable DT 6 oder
DALI dimmable DT 8 (TW only)

Deckeneinwurf:
non dimmable
DALI dimmable DT 6 oder
DALI dimmable DT 8 (TW only)

DATENBLATT – BASE 65 - GRADO
 BESPOKE - PIN
 PLATINENAUSWAHL ZUR KONFIGURATION



LED PLATINEN - TECHNISCHE DATEN

Monocolour und tuneable white

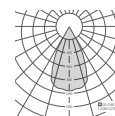
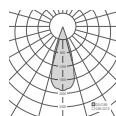
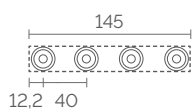

PIN

W	#Optik	CTT in K	φ LED lm	η 2x22°	φ Nutz lm	η 2x37°	φ Nutz lm
16	4	2700	1400	60%	840	70%	980
16	4	3000	1480	60%	888	70%	1036
16	4	4000	1560	60%	936	70%	1092
8	4	TW 2700/5700	700/820	60%	420/492	70%	490/574

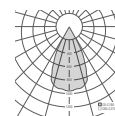
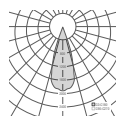
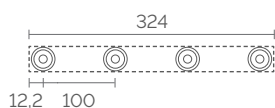

PIN

W	#Optik	CTT in K	φ LED lm	η 2x22°	φ Nutz lm	η 2x37°	φ Nutz lm
16	4	2700	1400	60%	840	70%	980
16	4	3000	1480	60%	888	70%	1036
16	4	4000	1560	60%	936	70%	1092
8	4	TW 2700/5700	700/820	60%	420/492	70%	490/574

LED Lichtstrom und Leistung je nach verfügbarer Selektion +/- 10%
 Toleranz Lichtfarbe +/- 150K

DATENBLATT – BASE 65 - GRADO
 BESPOKE - CONO
 PLATINENAUSWAHL ZUR KONFIGURATION



LED PLATINEN - TECHNISCHE DATEN

Monocolour und tuneable white

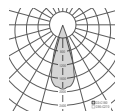
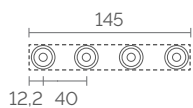

CONO

W	#Optik	CTT in K	φ LED lm	η 2x22°	φ Nutz lm	η 2x37°	φ Nutz lm
16	4	2700	1400	70%	980	75%	1050
16	4	3000	1480	70%	1036	75%	1110
16	4	4000	1560	70%	1092	75%	1170
8	4	TW 2700/5700	700/820	70%	490/574	75%	525/615

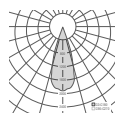
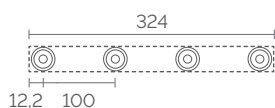

CONO

W	#Optik	CTT in K	φ LED lm	η 2x22°	φ Nutz lm	η 2x37°	φ Nutz lm
16	4	2700	1400	70%	980	75%	1050
16	4	3000	1480	70%	1036	75%	1110
16	4	4000	1560	70%	1092	75%	1170
8	4	TW 2700/5700	700/820	70%	490/574	75%	525/615

LED Lichtstrom und Leistung je nach verfügbarer Selektion +/- 10%
 Toleranz Lichtfarbe +/- 150K

ZUBEHÖR

Zubehör je nach Montageart separat bestellen:

Produkte	Montagearten	grau	weiss	schwarz
Enddeckel		313004	-5	-6
Befestigungsbohrung - Montagelöcher im Profil vorgebohrt; Ø 4,5mm		-	-	-
Einbaumontagebügel für GK-Decken 12,5mm		313008	-	-
Einspeiskabel L=2.000mm mit quadratischem Baldachin 3-polig		313012- 3	-5	-6
Einspeiskabel L=2.000mm mit quadratischem Baldachin 5-polig		313012- 5	-5	-6
Seilabhängung L=2.000mm, stufenlos höhenverstellbar		313014	-	-
Gipskarton Einbaukanal zur randlosen Montage in abgehängte Decken		313020	-	-

ZUBEHÖR - GIPSKARTON EINBAUKANAL

Gipsformteil zum bündigen Einbau in Gipskarton

L= 2.000 mm

BASE 32 und BASE 65

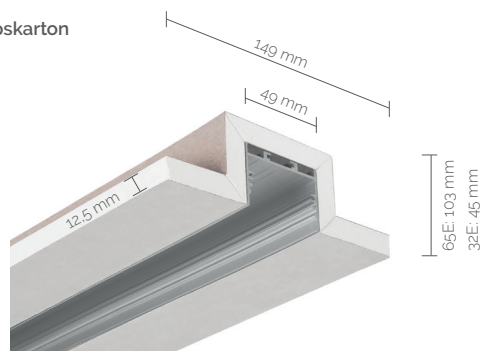

GRADO LINE - PROFILANWENDUNG



Reflektoren	BASE 32	BASE 33	BASE 42	BASE 52	BASE 65	BASE 66	BASE 70	BASE 85
2x22° PIN	X	X	✓	✓	✓	✓	✓	✓
2x37° PIN	X	X	✓	✓	✓	✓	✓	✓
Driver hinter Blindteil PIN	X	X	✓	✓	✓	✓	✓	✓
Driver hinter LED Inset PIN	X	X	X	X	✓	✓	✓	✓
2x22° CONO	X	X	X	X	✓	✓	✓	✓
2x37° CONO	X	X	X	X	✓	✓	✓	✓
Driver hinter Blindteil CONO	X	X	X	X	✓	✓	✓	✓
Driver hinter LED Inset CONO	X	X	X	X	X	✓	X	✓
indirekt	X	X	✓	✓	X	X	✓	X

DATENBLATT – BASE 65 - GRADO GROUP

ANSCHLUSSFERTIGE LEUCHTE

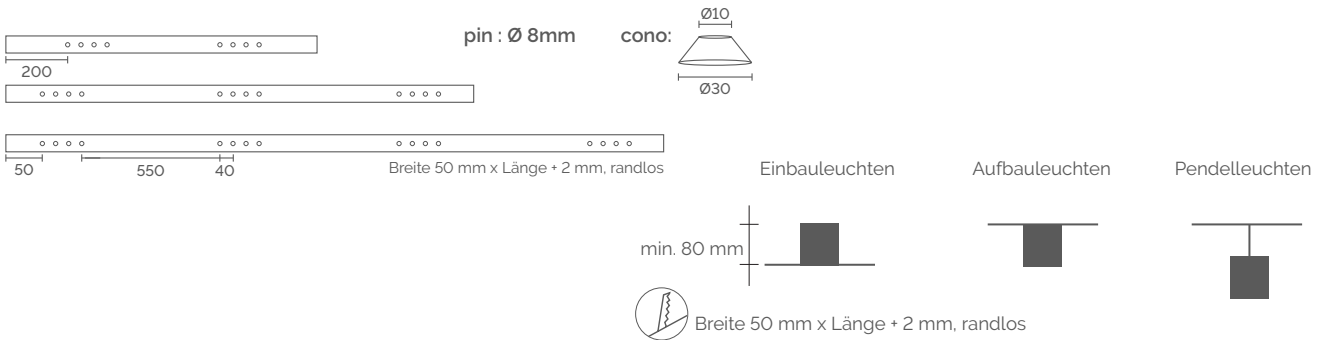

High Output

K	L=mm	W	lm	#optic	code	code	code
3000 K	1190	32	2.960	8	4065E21XY	4065A21XY	4065P21XY
CRI 90	1.560	48	4.440	12	4065E22XY	4065A22XY	4065P22XY
	2.230	64	5.920	16	4065E23XY	4065A23XY	4065P23XY

TECHNISCHE DATEN PER OPTIK

	W/optic	lm/optic	Φ led per optic
2700 K CRI 90	4	350	Φ led per optic
3000 K CRI 90	4	370	
4000 K CRI 90	4	390	
TW 2700 / 5700 K CRI 90 / CRI 80	2x2	175/205	

X_ LICHTFARBE / CCT

	code	Y_ OPTIK	code	η
2700 K	5	2 x 22° Linse + Pin	0	60 %
3000 K	6	2 x 37° Linse + Pin	1	70 %
4000 K	7	2 x 22° Linse + Cono	2	70 %
2700/5700 K	T	2 x 37° Linse + Cono	3	75 %

FARBEN CONO

schwarz	code lense + sw
chrom	code lense + cr
kupfer	code lense + cu
gold	code lense + go

+ _ OBERFLÄCHE

	code
A6 / C0	
RAL 9016 FS	5
RAL 9005 FS	6

RAL oder NCS Farbtöne auf Anfrage

+ _ ENERGIEVERSORGUNG

	nicht dimmbar
D	DALI dimmable DT 6
D8	DALI dimmable DT 8 (TW only)

tunable white nur DALI dimmbar lieferbar

ZUBEHÖR

Zubehör je nach Montageart inkludiert
 Enddeckel, Befestigungsbohrung, Einbaumontagebügel für GK-Decken 12,5mm, Einspeiskabel mit quadratischem Baldachin, Seilabhängung L=2.000mm, stufenlos höhenverstellbar, entsprechender LED Konverter im Blindteil der Leuchte integriert
 optionales Zubehör: Gipskarton Einbaukanal zur randlosen Montage

LED Lichtstrom und Leistung je nach verfügbarer Selektion +/- 10% Toleranz Lichtfarbe +/- 150K

$$\Phi_{\text{nutz}} = \Phi_{\text{led}} \times \eta$$

DATENBLATT – BASE 65 ANSCHLUSSBELEGUNG



3 POLIG - NICHT DIMMBAR

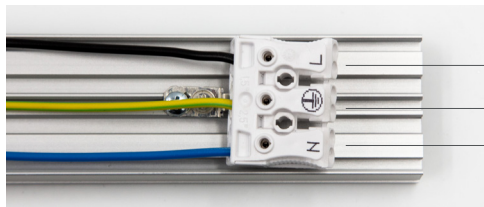

LEUCHTENSEITE

- L - SCHWARZ - PHASE
- ⊕ - GELB/GRÜN - SCHUTZERDUNG
- N - BLAU - NEUTRALLEITER

BAUSEITIGER ANSCHLUSS

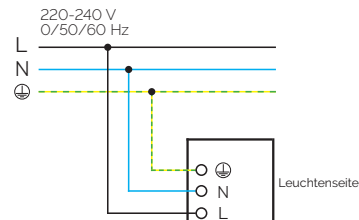

5 POLIG - DALI DIMMBAR

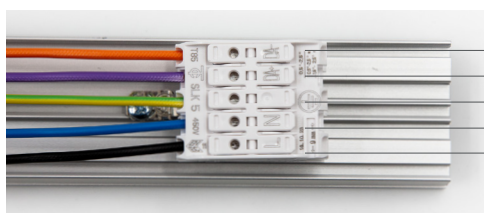

LEUCHTENSEITE

- DA- - ORANGE - DALI 2
- DA+ - VIOLETT - DALI 1
- ⊕ - GELB/GRÜN - SCHUTZERDUNG
- N - BLAU - NEUTRALLEITER
- L - SCHWARZ - PHASE

BAUSEITIGER ANSCHLUSS

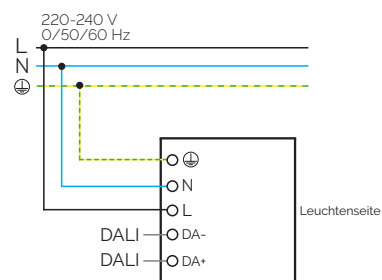

5 POLIG - PUSH DIMMBAR



LEUCHTENSEITE

- DA- - ORANGE - TASTER
- DA+ - VIOLETT - NEUTRALLEITER (gebrückt)
- ⊕ - GELB/GRÜN - SCHUTZERDUNG
- N - BLAU - NEUTRALLEITER
- L - SCHWARZ - PHASE

BAUSEITIGER ANSCHLUSS

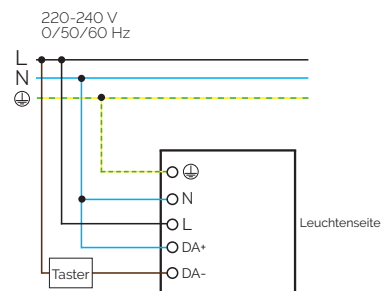

DATENBLATT – BASE 65
ANSCHLUSSBELEGUNG BALDACHIN UND
SEILABHÄNGUNG FÜR PENDELLEUCHTE



L: 80 mm
 B: 80 mm
 H: 35 mm



L=4.000mm auf Anfrage

3 POLIG - NICHT DIMMBAR

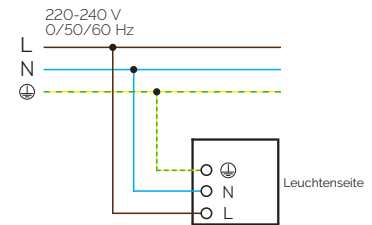
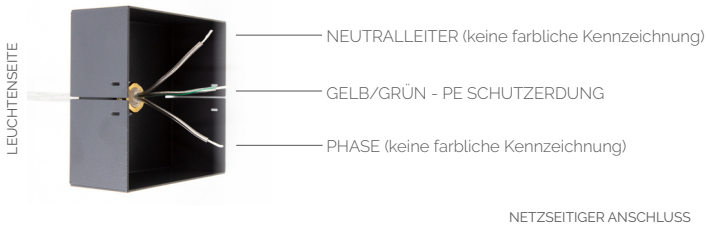

5 POLIG - DALI DIMMBAR

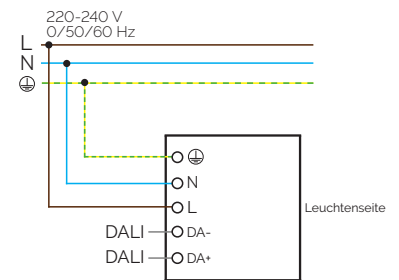
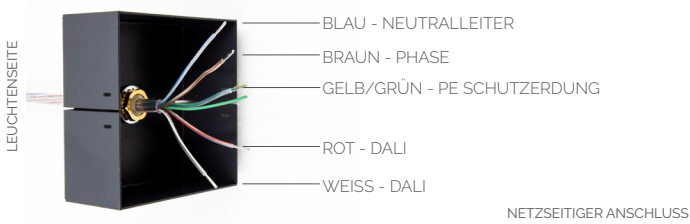

5 POLIG - PUSH DIMMBAR

